

INSTALLATION INSTRUCTIONS FOR THE EAX-500 EXIT ALARM (EAX-500 / 500W / 500SK)

EAX[®]

Dwg #: 102600



Table of Contents	Page
Parts breakdown view & part numbers.....	2
Hardware list, Device preparation.....	3
Switch selector positions, Door mounting & OKC procedure.....	4
Wall mounting procedure, Multi-door & SK procedure.....	5
Device installation, Key Stop installation, Optional accessories.....	6
Special notes & definitions, Magnet handing & re-handing, operations.....	7
Operations continued, Troubleshooting.....	8

The Detex EAX-500 is designed for applications that require an alarmed exit device on secured doors. The alarm, with approximately 100dB, will sound when someone attempts an unauthorized exit. The EAX-500, with it's smaller size makes it the choice for quick and easy installations on emergency exit and restricted doors.

Should you have any Question/Problem with your Detex device please call Detex Technical Support from the job site at 1-800-729-3839 and choose option 2 on our menu. Please do not return the product to the distributor.

For **WARRANTY** information,
scan code below or
go to www.detex.com/warranty



For device installation videos,
scan code below or
go to www.detex.com/videos





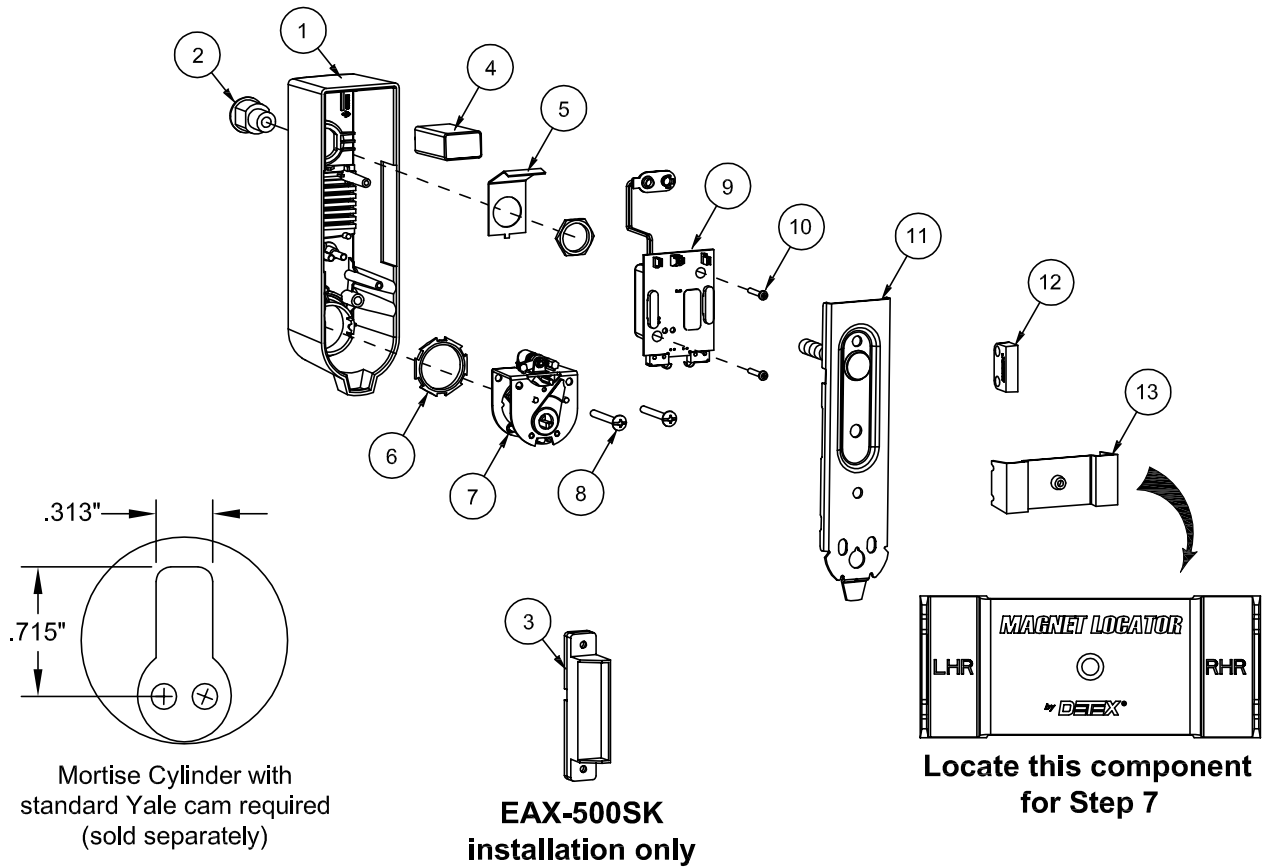

Owner's Copy

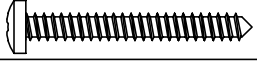

PARTS BREAKDOWN		
Item	Order Part #	Description
1	105428-1	Cover, gray
	105428-2	Cover, black
2	PP-5572	Cover Lock, Nut & 2 Keys
3	MS-1039S	Mag Switch (surface mount) (see STEP 8)
4	PP-5567	9 Volt Battery
5	102606	Battery Retainer
6	100783	Cylinder Nut
7	102655	Cam Assembly Kit
8	102627-15	8-32 Truss Head Screw
9	102656-1	Circuit Board Kit, Standard
	105838-1	Circuit Board Kit, Weatherized
10	PP-5374-46	#4 x 3/4" Screw, PPH
11	102715	Backplate
12	102665	Magnet Kit
13	102607	Magnet Locator
14	102633	Hardware Kit (includes keystone parts)(not shown)

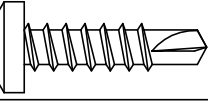
Your particular part or configuration may not be shown:
Contact Detex technical support at 800-729-3839 (option 2)

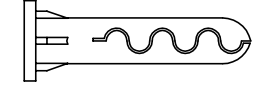
HARDWARE LIST		
SYMBOL	P/N & DESCRIPTION	DRILL SIZE
	P/N: PP-5183-29 #6 x 1-1/4" PPH, TYPE AB THREAD FORMING (SMS)	#35 (7/64")
	P/N: 100980 1/4-20 x 1" PPH MACHINE SCREW	#7 (.201")
	P/N: 103276-63 #14 x 1" PPH TYPE AB, SELF-DRILLING THREAD FORMING	7/32" or 3/16" (OPTIONAL)
	P/N: PP-5360-108 6-32 x 1/2" PPH TYPE C THREAD FORMING (ROLLING)	#32 (.116")
	P/N: 102642-3 1/4" x 1-3/16" ANCHOR	1/4"

STEP 1: REMOVE COVER FROM BACK-PLATE

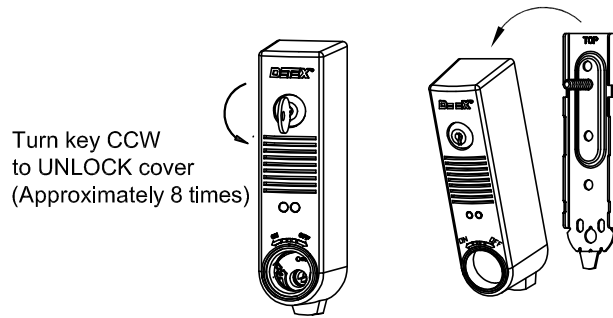

STEPS 2-6: PREP DEVICE

(If Key Stop is required, see **OPTIONAL KEY STOP** page 6)

2: Remove cam assembly from cover

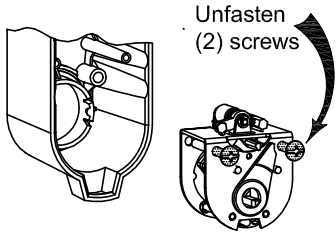

3: Install mortise cylinder (sold separately) with cylinder nut provided

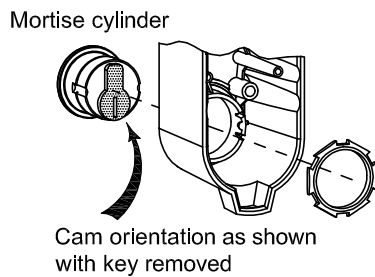

If 7-pin cylinder is used - OBSERVE

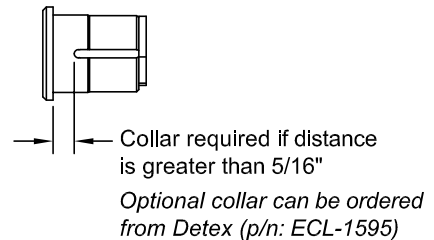

4: Re-install cam assembly

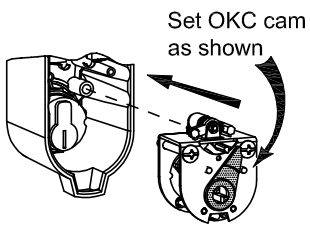

5: Set slide selector switch functions (See Table A on page 4)

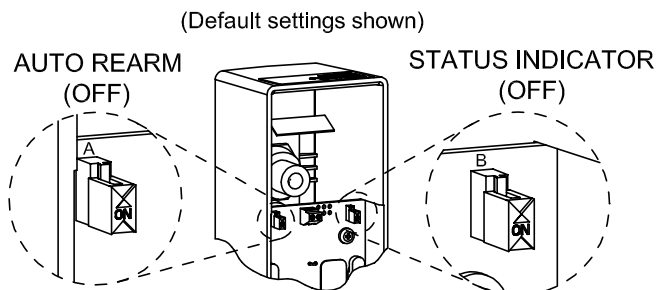

6: Connect 9-volt battery and install as shown

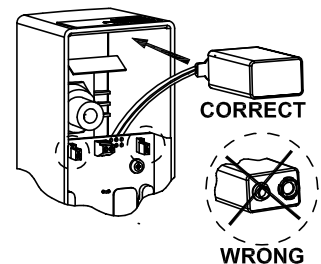
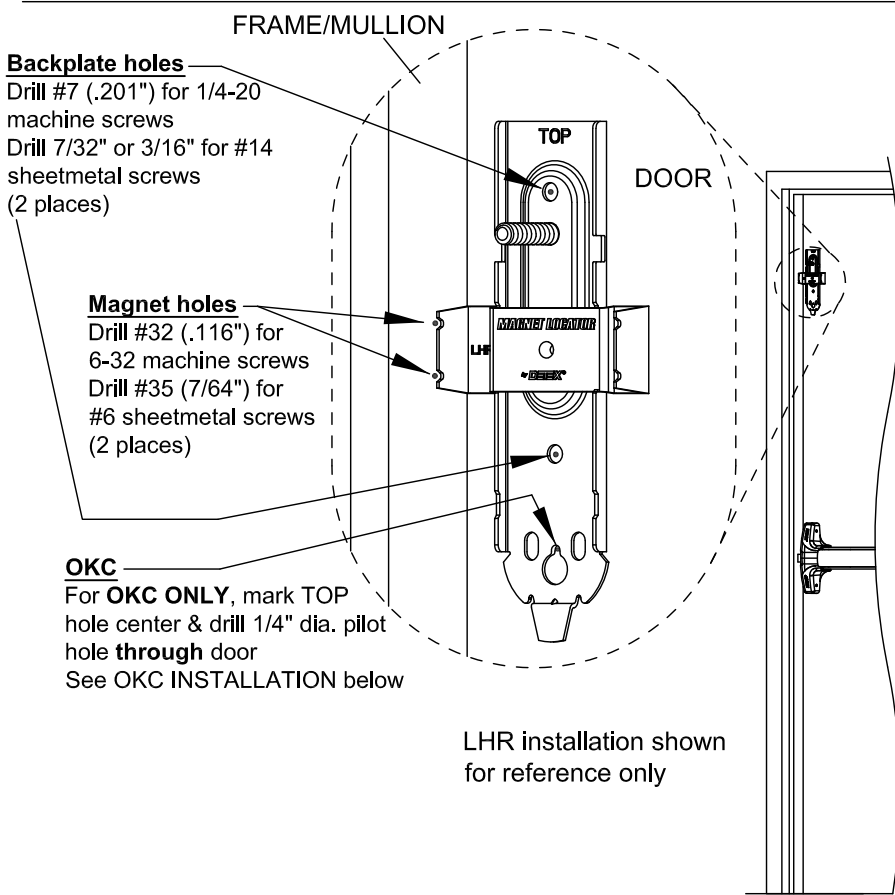

Table A: Selector Switch Functions (*Default settings; **Will shorten battery life)		
STATUS INDICATOR (Switch B)	OFF*	No indication that device is armed or disarmed.
	ON	ARMED - red LED blinks approximately every 3 seconds.** DISARMED - green LED blinks approximately every 3 seconds.**
AUTO REARM (Switch A)	OFF*	Key required to reset the alarm after it has been activated. Extended Bypass (see OPERATIONS page)
	ON	Alarm will automatically rearm 2 minutes after alarm has been activated and door closed. Custom settings can be programmed by DETEX. Non-Extended (Timed) Bypass (see OPERATIONS page)

STEP 7: For Door Mounting - Door Prep & Backplate / Magnet Mounting (for Wall mounting (SK) go to step 7B)

Place Backplate and Magnet locator on door as shown below.
Mark Backplate and Magnet holes on door and frame/mullion.
Remove Backplate and Magnet locator **before** drilling holes.



Install magnet and backplate

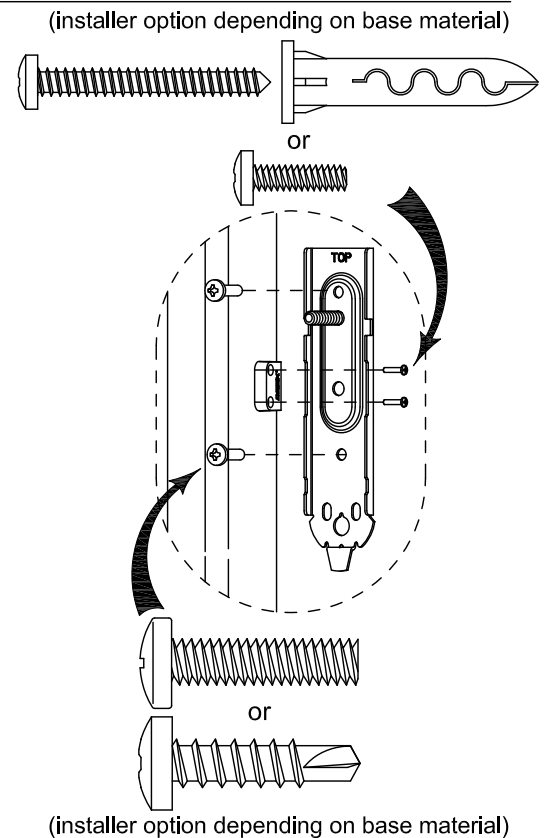

Skip to Step 9 to continue non SK installation

Outside Key Control (OKC) Installation (if required) (all models except SK)

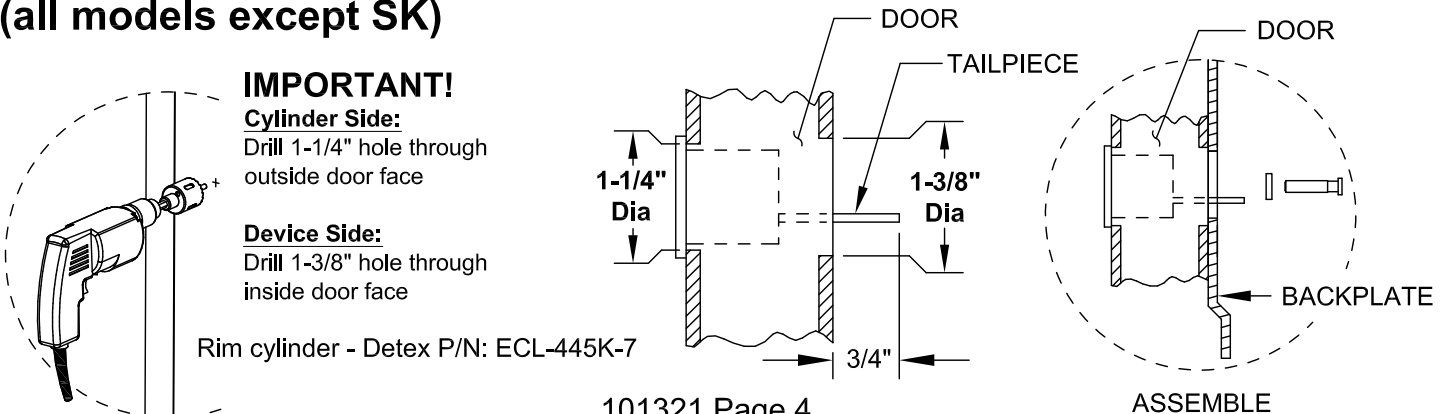

STEP 7B: For *Wall Mounting (SK)* - Backplate Mounting

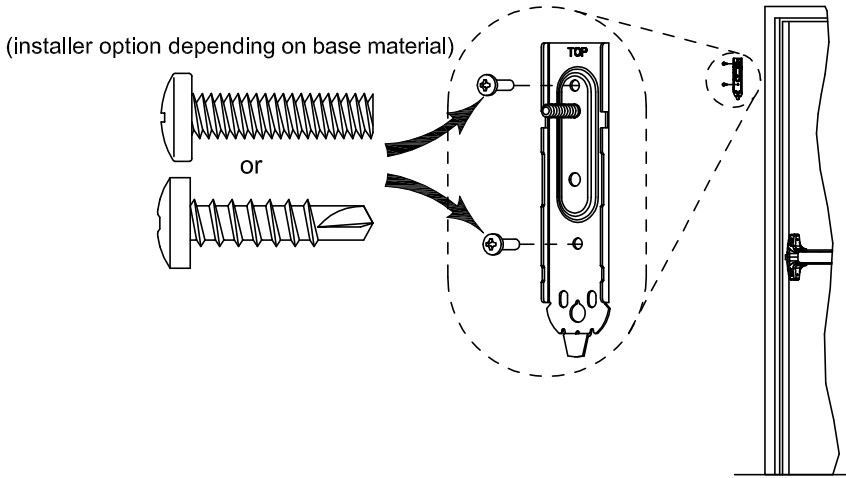

STEP 8: NOT FOR USE ON EAX-500W
Multi-door & SK function wiring connection (if required).

8a: Remove board

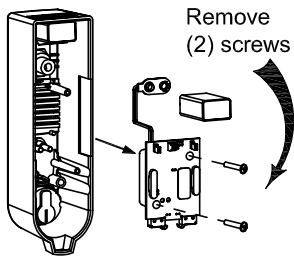

8b: Drill hole

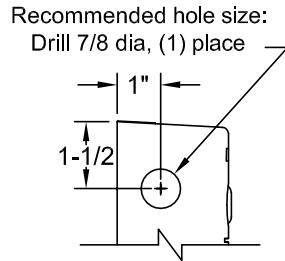

8c: Reassembly

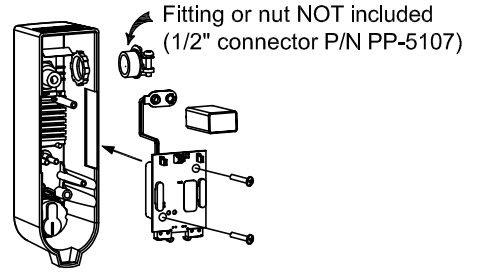

8d: SK Wire connections

Screw wires to (P1) terminal block
 (18ga Max wire dia) (not available on weatherized)

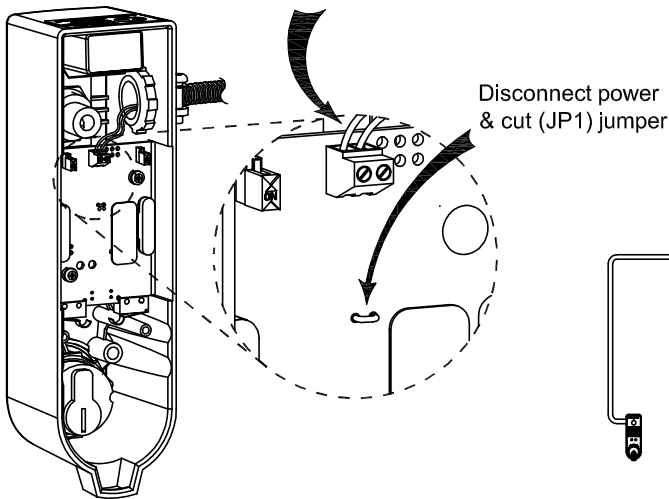
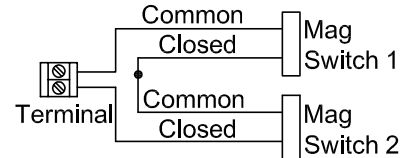
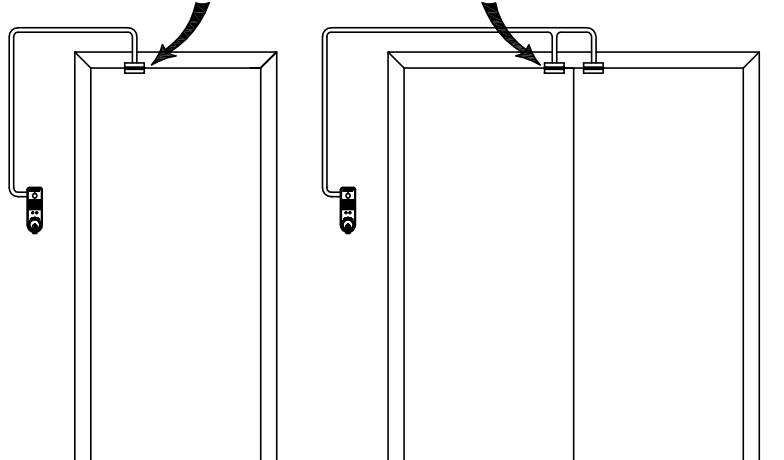

Diagram shown typical for two door magnetic switches:
 MS-1039S & MS-1059S wire in series.
 MS-2049 (Red wire not used)
 Weatherized not available for SK installations

Closed contact when door is closed



See instruction 103137 for magnetic switch mounting procedure



NOTES:

1. If wire runs longer than 10 feet, must use twisted pair.
2. 1/16" slotted jeweler screwdriver required.

STEP 9: INSTALL DEVICE

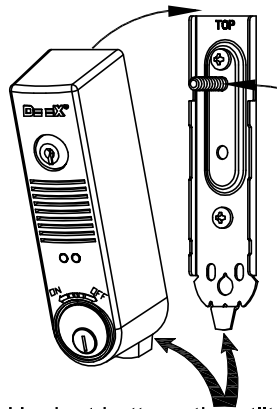

Applying a small amount of lube to threads will aid when removing the cover in the future.

Hook at bottom, then tilt cover over backplate

Turn key CW to lock cover
CAUTION:
 Do not over tighten

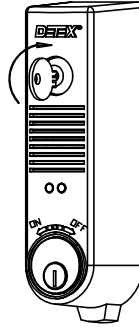

**OPTIONAL KEY STOP INSTALLATION
 (Not required for normal operation)**

(If required, key stop included in hardware kit)

Install key stop

P/N: 101976-1
 #4 x 3/8" PFH

Rotate key to this position before reinstalling cam assembly

KS shown
 p/n 105770-1

KS2 shown
 p/n 105770-2

KS used with standard Yale style cam

KS2 used with Adams Rite small style cam

**Front View
 (KEY STOP POSITIONS)**

<p>"ON" position (Key can be removed)</p>	<p>"OFF" position (Key cannot be removed)</p>
<p>Key and cams shown in 90° stop "ON" position</p>	<p>Key and cams shown in "OFF" position</p>

Optional Accessories

Cylinder Nut Tool
 P/N: 103779

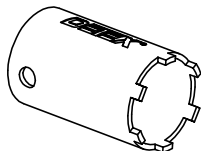

Inswing Door Kit
 P/N: 102644

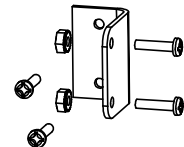

SPECIAL NOTES and DEFINITIONS:

1. The door needs to be closed to test the unit.
2. When operating the ON/OFF switch, there is a slight delay.
3. The key is inserted and removed only in the vertical position (home position).
4. Key function: counter clockwise (CCW) = Armed; clockwise (CW) = Disarmed
5. Outside Key Control (OKC)

The bottom left hand switch is only used when the outside key control function is used. This allows entry from outside. It bypasses the alarm & rearms in 15 seconds after the door closes. The OKC will not arm or completely disarm the alarm as the inside key does. When in Extended Bypass mode (Switch A, OFF) the unit will not rearm until 15 seconds after the door closes. The door can remain open if desired. When in the Timed Bypass mode (Switch A, ON) the unit will arm after 15 seconds & go into alarm if the door remains open.

MAGNET HANDING/RE-HANDING PROCEDURE: Magnet handing is where the device determines if the left, right or an external reed switch will be used to indicate if the door is opened or closed. When the battery is initially installed, the device simultaneously flashes the LEDs and chirps the siren a total of five times indicating the memory is cleared.

This indicates that the device is in the magnet handing process but not yet selected:

Step 1: Turn the key CW to the 'OFF' position.

Step 2: If re-handing is necessary, remove the unit from the door and momentarily short the *Mag Rst (or Test)* jumper contacts. The device simultaneously flashes the LEDs and chirps the siren a total of five times.

Step 3: With the door open, install the device on the door.

Step 4: Turn the key CCW to the 'ON' position. The red LED blinks twice.

Step 5: Close the door or bring the external magnet into position with the external door switch.

The siren chirps and the LED flashes on the selected side of the device (red LED flashes for the left side or external; green LED flashes for right side).

The device will now operate normally, and the selected reed switch side is stored in memory so changing the battery does not require re-handing.

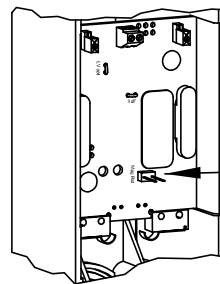

Mag Rst (or Test)
jumper contacts.

OPERATIONS: To arm the system, close the door and turn the key CCW to the 'ON' position.

The red LED will blink twice followed by the green LED flashing for the remainder of the arming time (default 15 seconds). After the arming time, the green light will turn off and the siren chirps/ red LED flashes three times. The device is now armed and if the door is opened the alarm will sound and the red LED turns on.

DISARMING: To turn off the alarm or disarm the system, turn the key CW to the 2 o'clock position.

AUTO REARM: With Switch A 'ON', alarm shuts off two minutes after closing the door.

EXTENDED/NON-EXTENDED (TIMED) BYPASS: With Switch A in the 'OFF' position, the unit operates in the extended bypass mode. This mode prevents the unit from arming while the door is open. Conversely, with Switch A in the 'ON' position, the unit operates in the non-extended (timed) bypass mode. This mode allows the unit to arm regardless of the doors position. If the door is not closed at the end of the arming delay, the unit will go into alarm.

Key orientation
without Key Stop
installed

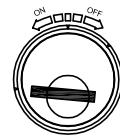

"ON"
position



"OFF"
position

Key orientation
with Key Stop
installed



"ON"
position



"OFF"
position

LOW BATTERY ALERT: Simultaneous siren chirps and red LED flashes occur at 45 second intervals when the battery reaches approximately 7 volts. Cut LV Opt jumper if low battery alert is not desired.

LV Opt jumper
(under Switch A)

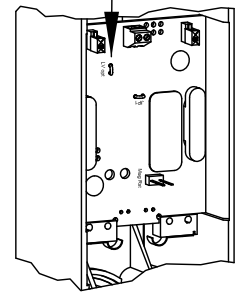

STATUS INDICATOR: With the Status Indicator switch (Switch B) 'ON', red LED flashes every three seconds when armed; green LED flashes every three seconds when disarmed.

ACTIVATE / DEACTIVATE SILENT ARMING: *NOTE: Device must be magnet handed.*

1. Turn the key CW to disarm and remove the unit from the door if installed.
2. Remove the battery.
3. Turn the key CCW to the 'ON' position. Hold the OKC switch lever (see detail view below) closed and install the battery. The unit chirps twice when silent arming is turned 'ON', and chirps once when silent arming is turned 'OFF'. Repeat the process to change between settings.
4. Release the OKC lever and turn the key CW. Reinstall the unit on the door.

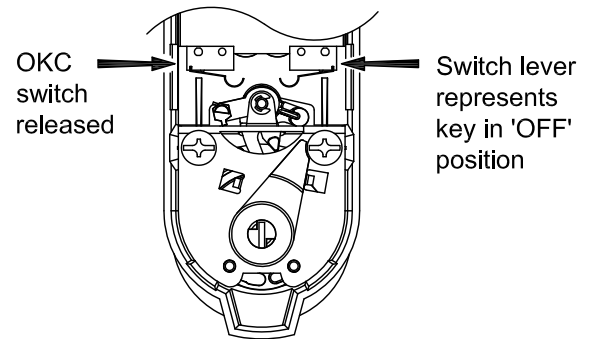
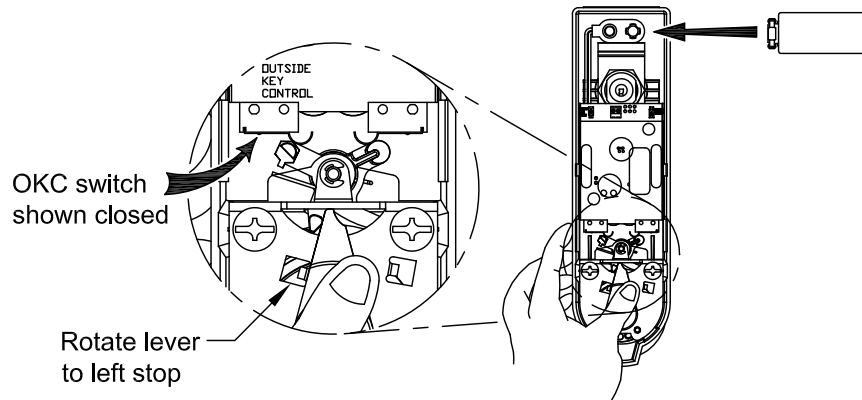

TROUBLESHOOTING

Problem	Probable Cause	Action
Device is not powering up.	Battery is dead.	Replace battery.
Device not arming.	<ol style="list-style-type: none"> 1) Needs to be rehand. 2) Cylinder microswitch lever broken. 3) Cylinder installed incorrectly. 4) Magnet not aligned correctly. 	<ol style="list-style-type: none"> 1) Rehand 2) Microswitch needs to be replaced. Remove PCB and return to Detex repair. 3) Check cylinder installation. Make sure key is turned counter-clockwise all the way to ON. 4) Use magnet locator to install magnet. See magnet handing.
Chirp every 45 seconds	Low Battery.	Install new battery.
No status indicator	Status indicator (Switch B) is OFF.	Slide Status Indicator (Switch B) slide switch to the ON position.
Unit is not Auto Rearming	Switch A is OFF.	Slide Switch A slide switch to the ON position.
For wall mounting Wired magnet switch not working	<ol style="list-style-type: none"> 1) Device is not modified for external wired magnet switch. 2) MS-2049 not wired correctly. Red wire should not be used. 	<ol style="list-style-type: none"> 1) Remove battery, cut JP1 jumper. With battery connected, short "Test mode" pins, listen for 5 chirps. See RE-HANDING section. 2) Use MS-2049 black and white wires to green connector on PCB.
One side does not work.	Unit is handed on the wrong side.	See RE-HANDING section.
The alarm sounds after the time delay	<ol style="list-style-type: none"> 1) Door not closed. 2) magnet not aligned. 	<ol style="list-style-type: none"> 1) Close door and rearm the alarm. 2) Use magnet locator to install magnet. Shim as needed. Adjust as necessary.
Chirps 5 times when battery is plugged in.	Device needs to be handed.	See magnet handing procedure